

# FLUID POWER LAB

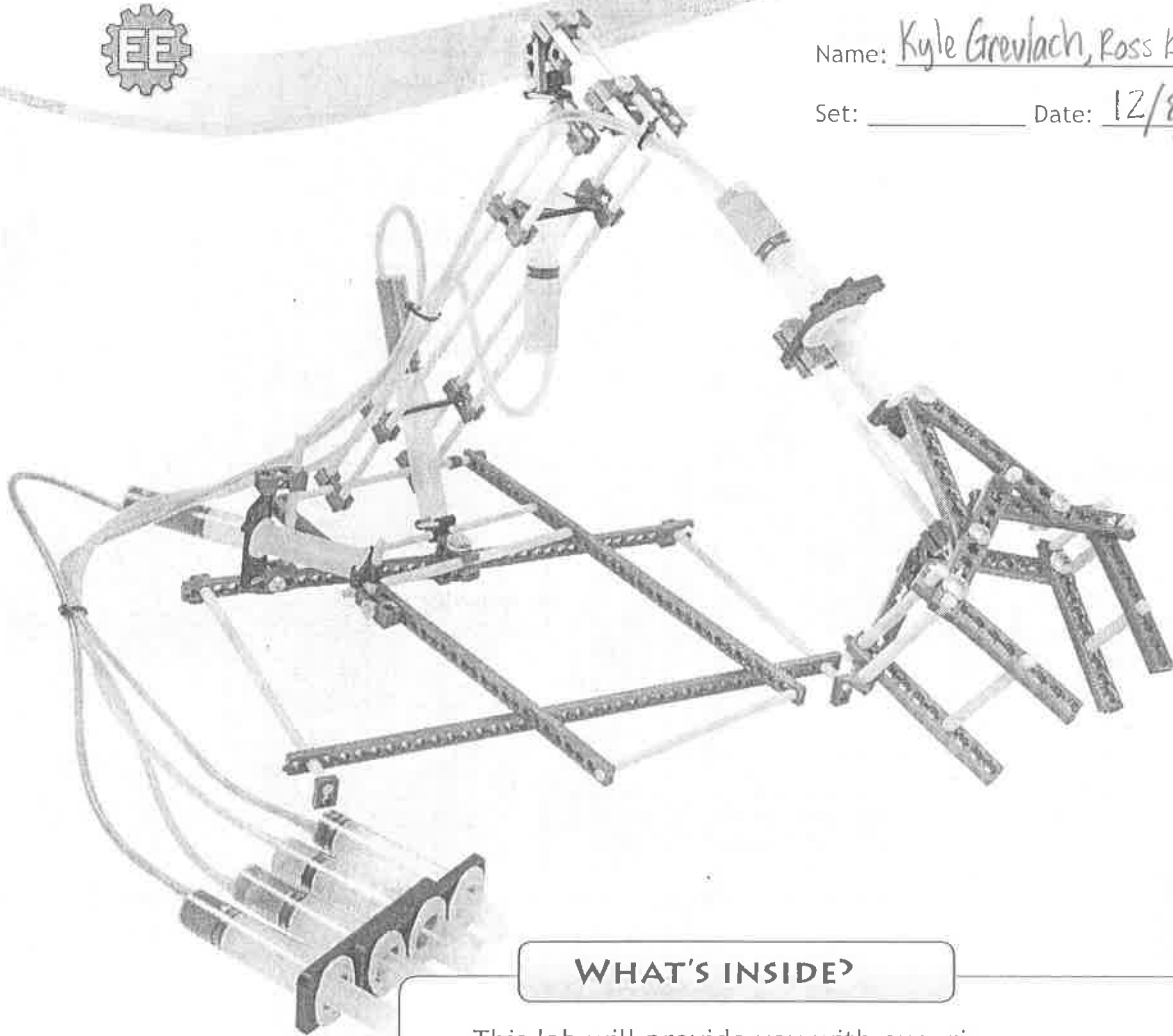

Name: Kyle Grevlach, Ross King, Dan Loddeke.

Set: \_\_\_\_\_ Date: 12/8/14



## WHAT'S INSIDE?

This lab will provide you with experiences with and an understanding of:

- Hydraulic Systems
- Pneumatic Systems
- Cylinders
- Pascals Law
- Liquids and Gasses
- Pressure
- Kinetic and Potential Energy
- Mechanical Advantage
- Friction
- Viscosity
- Work

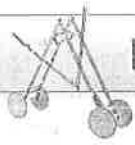

## FLUID POWER

Fluid power is an area of technology dealing with the generation, control and transmission of pressurized fluids.

A fluid can be a gas or a liquid.

### PNEUMATICS

Pneumatic systems use a **gas** to transmit and store power.

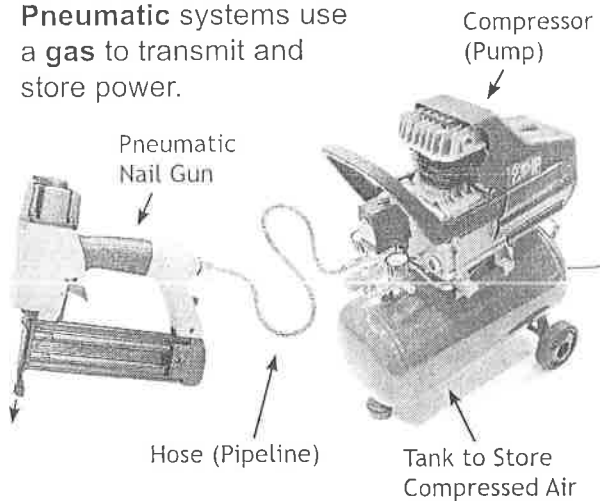

### HYDRAULICS

Hydraulic systems use a **liquid** to transmit power.

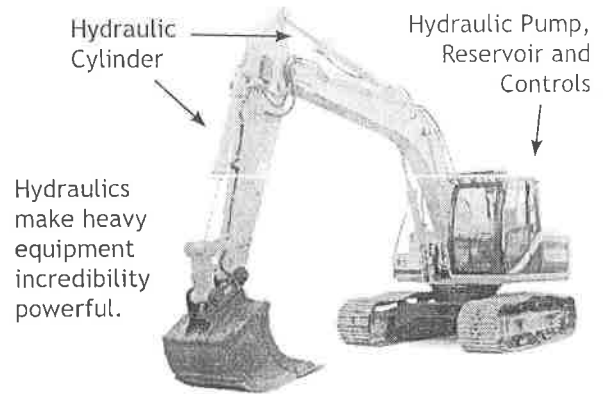

### Pneumatic Devices

1. List 2 devices that use pneumatics for operation. Describe how they use pneumatics.

Device	How does it use pneumatics?
Dental drill	Uses air to move the drill
Jackhammer	Powered by compressed air

### Hydraulic Devices

2. List 2 devices that use hydraulics for operation. Describe how they use hydraulics.

Device	How does it use hydraulics?
Crane	To lift the arm
Jacks	Lifts up a car

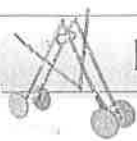

## CYLINDERS

Cylinders transform pressure and fluid flow into mechanical force.



### ANATOMY OF A CYLINDER

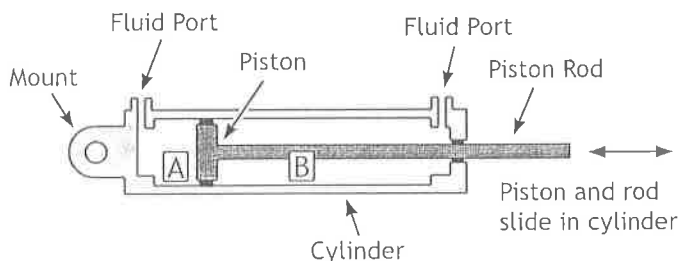

Chambers **A** and **B** are sealed, so fluid can only enter or exit through the ports. Pressure in a chamber creates a force on the piston.

### DOUBLE-ACTING CYLINDERS

Most cylinders are double-acting. Double acting cylinders allow pressurized fluid to flow on either side of the piston, allowing it to be powered in both directions.

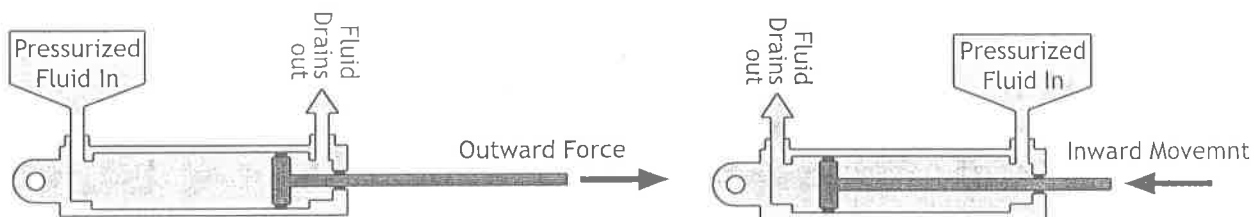

### SINGLE-ACTING CYLINDERS

Single acting cylinders are only powered in one direction. The piston is returned by the weight of the load or a spring.



The pumps that power cylinders can usually only create a positive fluid pressure (push fluid). That is why most cylinders, like the ones shown above, are designed to only be powered by positive fluid pressure.

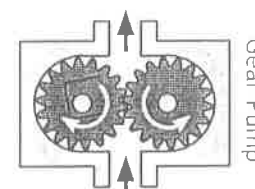



## YOUR CYLINDERS WILL PULL & PUSH

You will use a cylinder as a pump. The cylinder will be able to push fluid (creating a positive pressure), or pull fluid (creating a negative pressure). This will allow your cylinders with a single port to be powered in both directions.

✓ the correct answers below:

3. There is a  Positive pressure in line Z.  Negative

4. Piston Y is moving  inward  outward

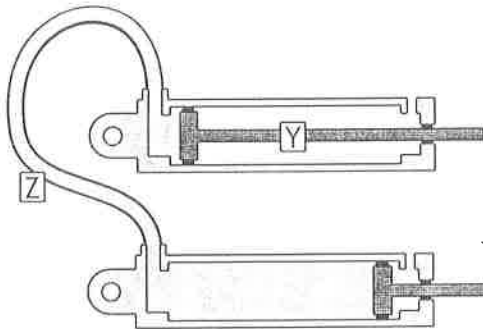

This piston is being pulled out. →

## SYRINGES AS CYLINDERS

You will be turning syringes (not the ones with needles) into pneumatic and hydraulic cylinders. Match the components with their name by placing letters into the boxes below:

- 5. Piston:
- 6. Piston Rod:
- 7. Cylinder:
- 8. Fluid Port:
- 9. Mount:
- 10. Clip:

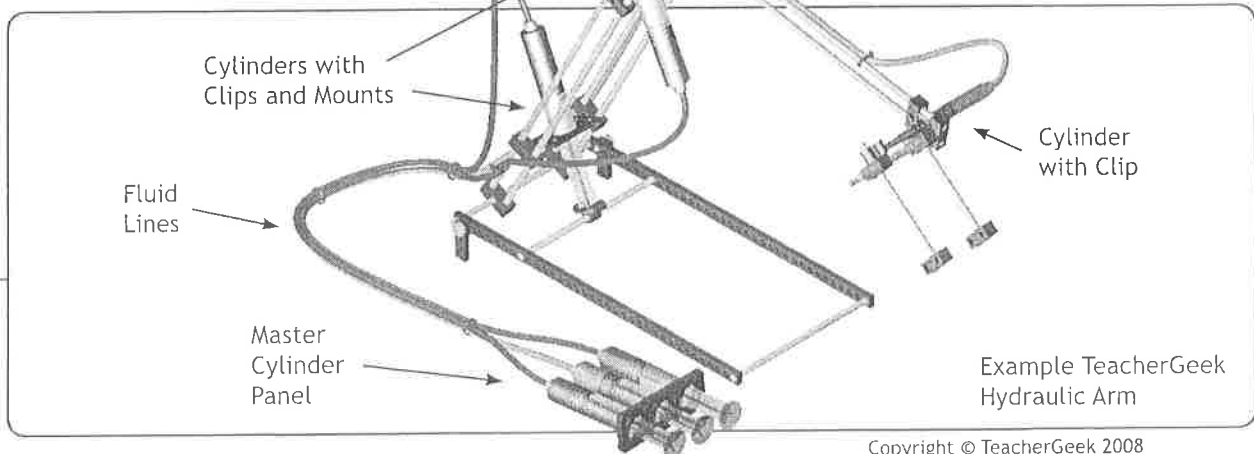
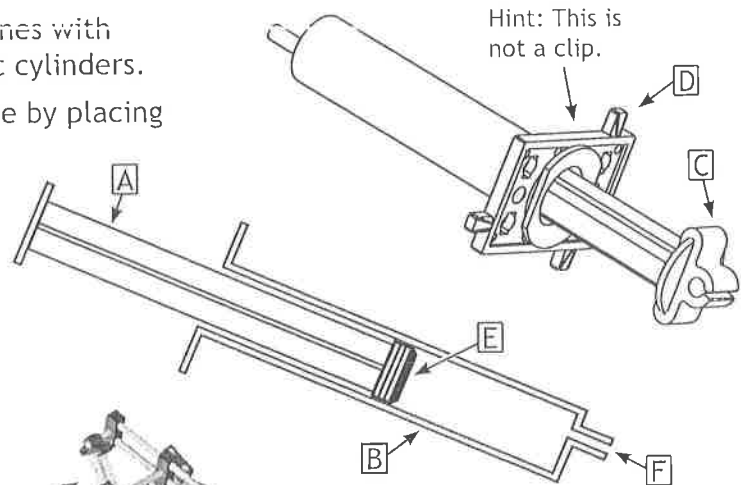

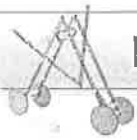

## WHAT IS PRESSURE?

Pressure is a force applied over an area:

$$\text{Pressure} = \frac{\text{Force}}{\text{Area}}$$

The area over which the force is applied.

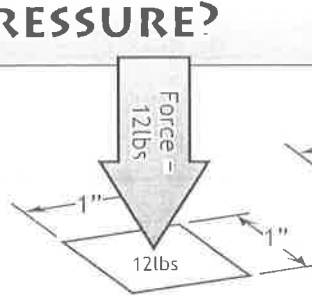

$$1\text{in} \cdot 1\text{in} = 1\text{in}^2$$

$$\frac{12\text{lbs}}{1\text{in}^2} = 12\text{lbs/in}^2$$

Less Area = More Pressure

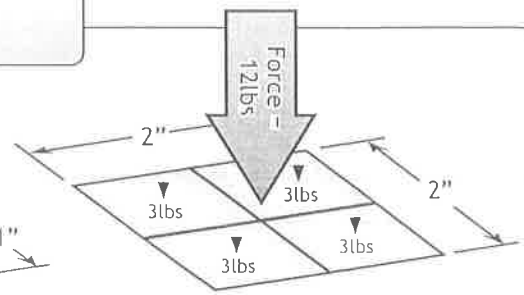

$$2\text{in} \cdot 2\text{in} = 4\text{in}^2$$

$$\frac{12\text{lbs}}{4\text{in}^2} = 3\text{lbs/in}^2$$

More Area = Less Pressure

Step 1: Push the piston end of a 10ml cylinder against your hand.



Step 2: Use the same amount of force as you did for step 1 to push the fluid port end of the 10ml cylinder against your hand.

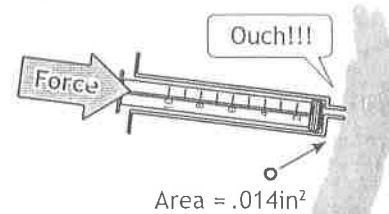

11. Both ends of the cylinder were pushed against your hand with the same force. Explain why they felt different? Hint: Pressure = Force/Area

The small end creates more pressure because with the same force, a smaller area would create more pressure

## PUTTING YOUR FOOT DOWN

A foot pushes down on a 3in<sup>3</sup> cube with 45lbs of force.

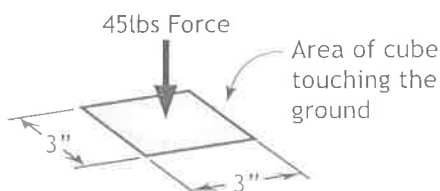

12. How much pressure does the cube apply to the ground?

Show your work:

$$P = F/A = 45\text{lbs}/9\text{in}^2 = 5\text{lbs/in}^2$$

Answer:  $5\text{lbs/in}^2$



## FIND THE UNKNOWN

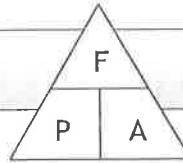

Lets look at another way to write the formula  
 Pressure = Force/Area.

Pressure =  $\frac{\text{Force}}{\text{Area}}$  can be written as:



P = Pressure  
 F = Force  
 A = Area

Use this chart to find the formula to calculate a missing variable (force, pressure, area).

Cover the missing variable up on the chart to find the formula to calculate it:

You know: Pressure, Area  
 You need to find: Force



Force = Pressure • Area

You know: Force, Area  
 You need to find: Pressure

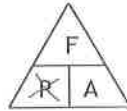

Pressure = Force/Area

You know: Pressure, Force  
 You need to find: Area



Area = Force/Area

13. Pressure transfers between the piston and the fluid in the cylinder. Calculate the force of the piston when the fluid applies 20lbs/in<sup>2</sup> to it. Show your work.

What is the force of the piston?

Piston Area = 1.5in<sup>2</sup>

$$20 \text{ lbs/in}^2 = F / 1.5 \text{ in}^2$$

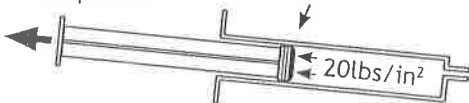

Answer:  lbs

## MEASUREMENTS OF PRESSURE

### LBS/IN<sup>2</sup> (PSI)

A force of 1 pound applied over an area of 1 square inch produces a pressure of 1 pound per square inch (1lb/in<sup>2</sup>)

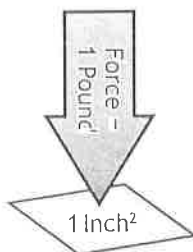

= 1 psi

pounds per square inch can be abbreviated as "psi"

### PASCAL (PA)

A force of 1 newton applied over an area of 1 square meter produces a pressure of 1 pascal.

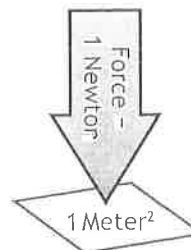

= 1 Pa

Pascal can be abbreviated as "Pa"



## PASCAL'S LAW

Pascal's Law: A confined fluid transmits an externally applied pressure uniformly in all directions.

Piston **A** applies pressure to the fluid inside chamber **B**. The fluid transmits the pressure in every direction and to every surface it touches.

14. If the pressure is 5psi in chamber **B**, what is the pressure in line **C** and chamber **D**?

Answer:  psi

*5 psi in all directions everywhere*

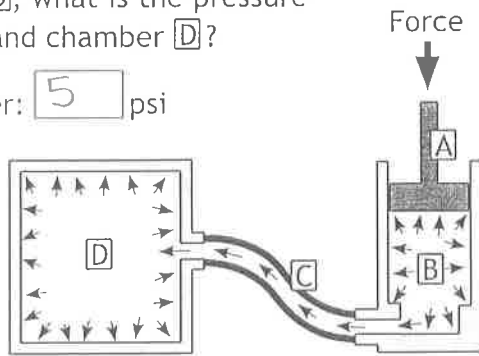

Squeezing a toothpaste tube is an example of Pascal's Law.

Squeezing a toothpaste tube applies an external pressure to the toothpaste fluid inside. The toothpaste transmits the force equally in all directions, pushing the toothpaste out of the end and making the tube walls bulge.

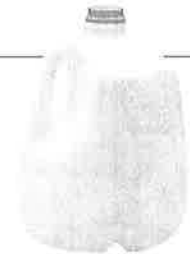

1 cubic centimeter (cc)  
= 1 milliliter (ml)  
Something you never wanted to know...  
3785.4ml = 1 gallon

## PRESSURIZING MARSHMALLOWS

1<sup>st</sup> Pull the piston out from a 10cc cylinder (syringe) and place one small marshmallow inside the chamber.

2<sup>nd</sup> Push the piston in while covering the fluid port with your finger. Watch what happens to the marshmallow.

3<sup>rd</sup> Push the piston in with your finger off the port.

4<sup>rd</sup> Put your finger over the port and pull the piston back. Watch the Marshmallow.

15. What happened to the marshmallow?

*Shrinks*

16. Why, according to Pascal's Law, did the marshmallow equally grow and shrink on all sides?

*Because the applied pressure acts uniformly in all directions*

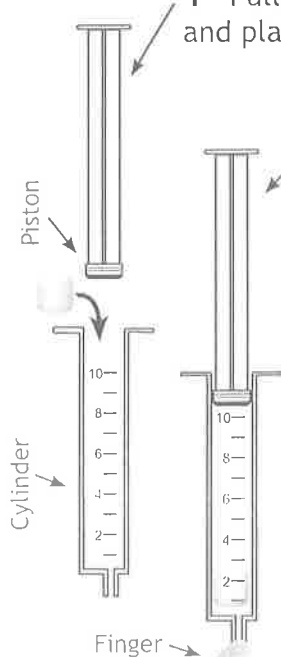

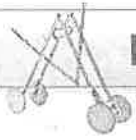

# CAACLULATING PRESSURE

## EXAMPLE CALCULATION

Force = 20lbs

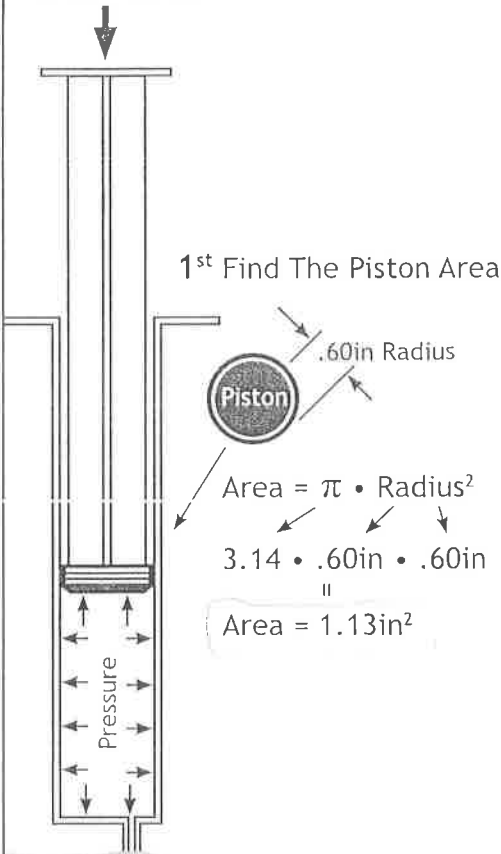

2<sup>nd</sup> Calculate Pressure:

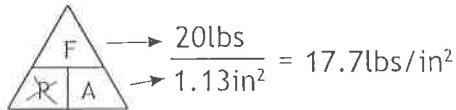

Answer:

Air pressure inside the cylinder = 17.7psi (lbs/in<sup>2</sup>)

Most pneumatic nail guns use 60-100psi

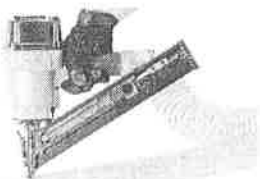

## YOUR CALCULATION

17. Calculate the pressure inside the cylinder.

Force = 7lbs

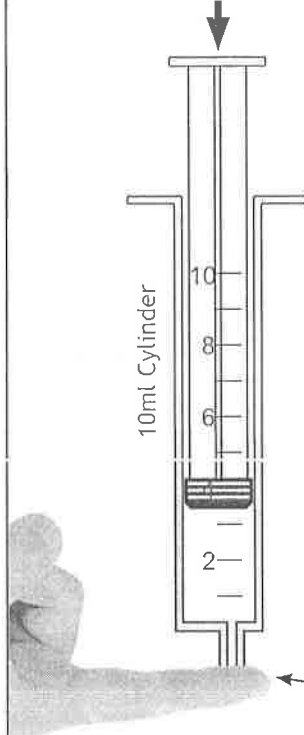

Formulas:

Area =  $\pi \cdot \text{Radius}^2$

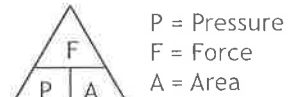

Note: Measure an actual 10ml syringe and find the area of its piston (do not measure the drawing on this paper).

Show your calculations below:  $(.35\text{in})^2 \cdot \pi$

$P = F/A = 7\text{lbs}/.385$       Area = .385

$P = 18.2 \text{ psi}$

Answer: 18.2 psi





## PNEUMATIC PLAY

You will need a 10ml-10ml pneumatic system for this section.

### PUSH ONE PISTON

Push and pull piston **A**. Examine what happens and answer the questions below.

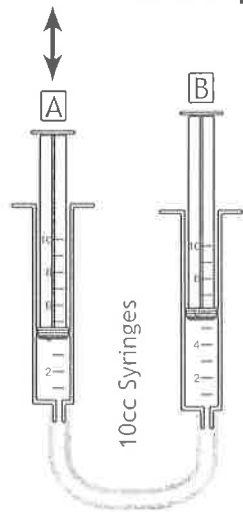

Complete the following sentences using some of these words: faster, liquid, slower, inversely, transfers, gas, force, fluid, solid. Words can only be used once.

- The pistons move **inversely** to each other.
- Piston **B** moves **slower** than piston **A** (the piston you pushed and pulled) due to air compressing.
- The pressure applied by piston **A** **transfers** though the **gas** (air) to piston **B**, applying a **force** that causes piston **B** to move.

### PUSH BOTH PISTONS

Push in both pistons. Examine what happens and answer the questions below.

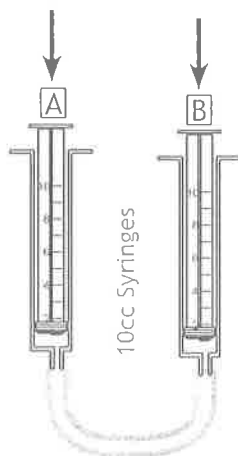

Complete the following sentences using some of these words: pressure, force, psi, potential, compresses, kinetic. Words can only be used once.

- An external **force** is needed to move the pistons into the cylinders.
- The pressure applied by the pistons **compresses** the air in the cylinders and line.
- Psi** means the same thing as lbs/in<sup>2</sup>.
- Compressed air has **potential** (stored) energy.
- After pushing both pistons in, quickly let go of one piston. The piston you let go of moves outward with **kinetic** energy.

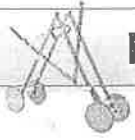

## SHARING PRESSURE & FLUID

How does fluid pressure transfer between cylinders? How can a force applied to one piston cause the other piston to move? Fill in the boxes below to find out.

### PISTON C APPLIES PRESSURE

26. Complete the formula to find the pressure applied by piston C:

$$\frac{F}{P \cdot A} = \text{Pressure}$$

4 lbs
= Pressure  
2 in<sup>2</sup>

27. Pressure inside Chamber G = 2 psi

### FLUID TRANSFERS THE PRESSURE

28. pressure is transmitted from chamber G through line I to chamber H.

29. The pressure inside chamber H = 2 psi

### PISTON D TURNS PRESSURE INTO FORCE

30. The fluid pressure applied to piston D = 2 psi

31. Complete the equation and find the force of piston D:

We know pressure and area, but need to find force.



$$\text{Force} = \text{Pressure} \cdot \text{Area}$$

2 psi
• 2 in<sup>2</sup>  
Force of Piston D = 4 lbs

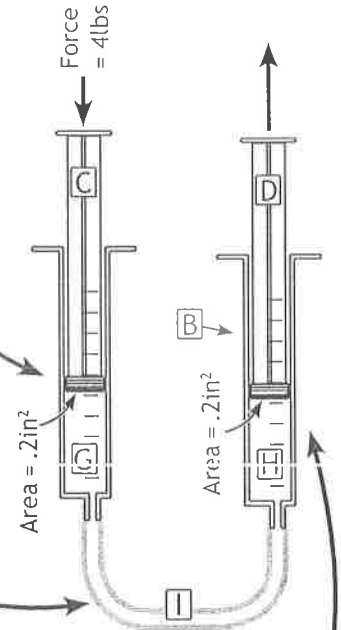

### MASTER & SLAVE CYLINDERS

32. The cylinders above can be referred to as a master cylinder and slave cylinder. Why do you think cylinder B is referred to as the slave cylinder?

It is the cylinder that is being affected because of cylinder A





## FRICITION

Friction is a force that opposes the motion of an object, when the object is in contact with another object or surface. It turns some of the objects kinetic energy into heat.

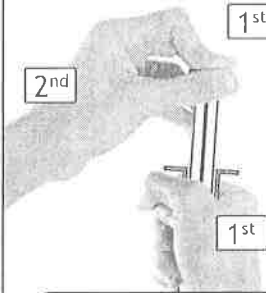

**1<sup>st</sup>** Grip the cylinder. **2<sup>nd</sup>** Push and pull the piston 30 times, as fast as you can.

**33.** What happens to the cylinder as you move the piston? Why does this happen?

*It gets hotter because of the kinetic energy created*

When liquid flows in a hydraulic circuit, friction produces heat (wasted energy).

How can you reduce friction in your hydraulic system?

- Shorten the lines
- Reduce bends in the line
- Properly size the line

**34.** Draw a line that would highly resist the flow of fluid between cylinders:



## VISCOSITY

Viscosity: A measure of a fluids resistance to being deformed.

Viscosity is fluid's resistance to flowing. It can also be called its thickness.

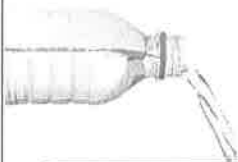

Water is "thin" and has a low viscosity



Katchup is "thick" and has a higher viscosity.

**35.** Write the following words in the boxes below so they are arranged from least viscous to most viscous: Milk, Honey, air, Peanut Butter

Least Viscous

*Air*

*Milk*

*Honey*

*Peanut Butter*

Most Viscous



## NON-NEWTONIAN FLUIDS

Fluids without a constant viscosity are called Non-Newtonian fluids. You can experience a Non-Newtonian fluid...

Mix 2 cups of cornstarch with 1 cup water.



+



=

A fluid that changes viscosity depending on the pressure applied to it.



Points:

Bonus Points:

Find a new use (good use) for a Non-Newtonian fluid. Present it to your class.

## HYDRAULICS

Now we will use a **liquid** to transmit power between cylinders. You will need a 10ml-10ml and a 3ml-10ml hydraulic systems for this section.



## HYDRAULIC BOOK WORK

Create the mechanism shown. Pushing piston **A** should lift the book.

36. Show your teacher the completed mechanism. Explain how it changes force to pressure, transfers the pressure, and then changes it back into force.

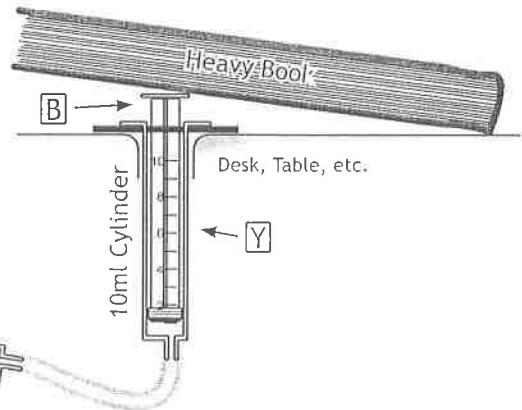

Teacher Signature:

37. Push in piston **A** 1 inch, piston **B** moves  out of cylinder **Y**.

38. Pull back piston **A** 1 inch, piston **B** moves  into cylinder **Y**.

39. Pneumatic fluid is highly compressible. How compressible is hydraulic fluid?

Not as compressible

40. When you push piston **A**, piston **B** moves immediately. How is this different than the pneumatic system you previously used?

It is delayed

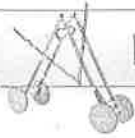

## BUBBLES ARE BAD

41. Why is it bad to have air bubbles in a hydraulic system?

- A. Air bubbles will not compress, but hydraulic fluid will.
- B. The air in the system will expand or contract, causing the system to become delayed and transfer less pressure.
- D. You can giggle and say that it "has gas."

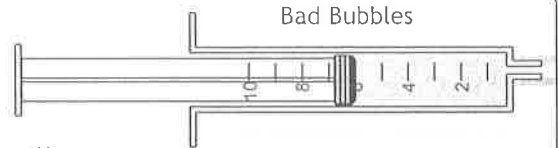

This is a tool for bleeding (removing the air from) brake lines on cars.

## WORK

The scientific definition of work: Using a force to move an object a distance.

$$\text{Work} = \text{Force} \cdot \text{Distance}$$

**Force:** The pull or the push on an object, resulting in its movement.

The distance over which the output force is applied

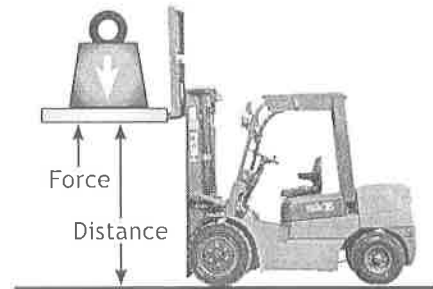

Forklifts use hydraulics to perform work (moving loads).

## WORK ON WORK

42. If schools used the scientific definition for work, how could homework be different?

*You would push the homework upward*

43. The following diagram shows cylinders that have lifted weights. Place an "X" under the cylinder that has done the most work?

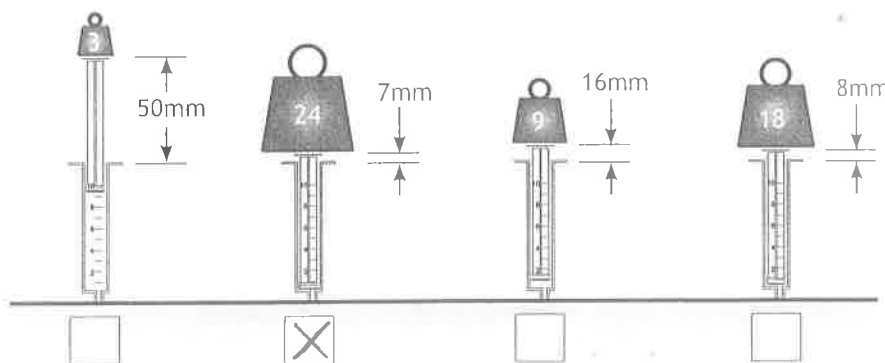

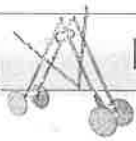

## MECHANICAL ADVANTAGE

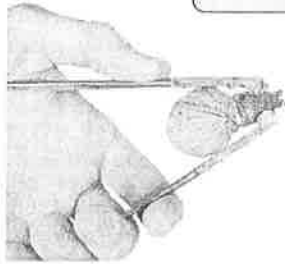

A nutcracker allows you to apply a force larger than you could with your bare hand.

Mechanical Advantage is the relationship between the work going into a system, and work coming out of a system.

Force can be traded for distance, or distance can be traded for force.

### IMA vs. AMA

Some energy will be lost by a machine (mostly through friction).

**Ideal Mechanical Advantage (IMA)** does not account for any energy lost.  $Work_{in} = Work_{out}$  with IMA

**Actual Mechanical Advantage (AMA)** accounts for energy lost.  $Work_{out} < Work_{in}$  with AMA

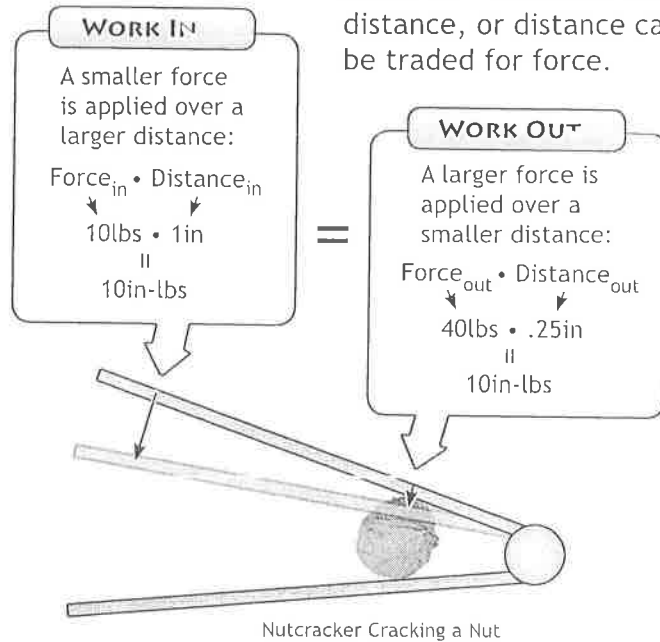

## IDEAL MECHANICAL ADVANTAGE

$$Work = Force \cdot Distance$$

so...

$$Work_{in} = Work_{out}$$

$$Force_{in} \cdot Distance_{in} = Force_{out} \cdot Distance_{out}$$

Input Force  
Also called "Effort"

The distance over which the input force is applied

Output Force  
Also called "Load"

The distance over which the output force is applied

$Work_{out}$   
This large cylinder moves a small distance with great force.

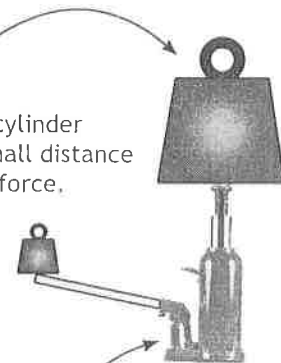

$Work_{in}$   
This small cylinder is repeatedly moved up and down (a large distance) with little force.

42. Calculate the output force:

$$\begin{array}{ccccccc}
 Force_{in} & \cdot & Distance_{in} & = & Force_{out} & \cdot & Distance_{out} \\
 \parallel & & \parallel & & \parallel & & \parallel \\
 250lbs & & 25in & & \boxed{625in} & & 10in
 \end{array}$$

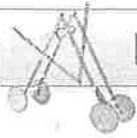

## IDEAL MECHANICAL ADVANTAGE (CONTINUED)

$$\text{Force}_{in} \cdot \text{Distance}_{in} = \text{Force}_{out} \cdot \text{Distance}_{out}$$

can be rearranged" as

$$\text{Ideal Mechanical Advantage} = \frac{\text{Distance}_{in}}{\text{Distance}_{out}} = \frac{\text{Force}_{out}}{\text{Force}_{in}}$$

Divide the  $\text{Distance}_{in}$  by the  $\text{Distance}_{out}$  or the  $\text{Force}_{out}$  by the  $\text{Force}_{in}$  to find the mechanical advantage.

42. Calculate the  $\text{Force}_{out}$ :  $55 = \frac{x}{23 \text{ lbs}}$   
 $\text{Force}_{in} = 23 \text{ lbs}$   
Ideal Mechanical Advantage = 55  
 $\text{Force}_{out} = 1265 \text{ lbs}$

Calculating mechanical advantage:

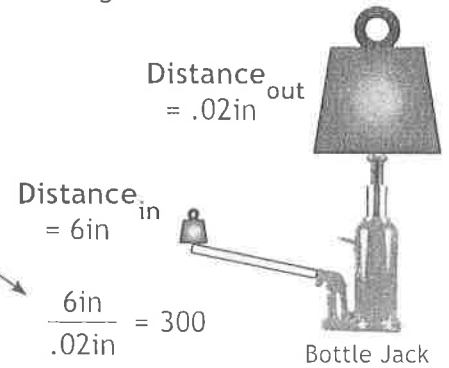

The ideal mechanical advantage of the jack can be represented as:

"300" or "300:1" or "300 to 1"

## DISTANCE FOR FORCE

Set up the 3ml to 10ml hydraulic system, as shown, so it will lift a book. Experiment with it and answer the questions below.

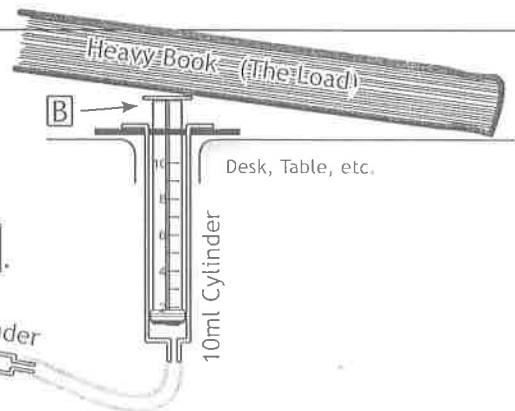

43. If piston A moves 1 inch, piston B moves  $3/10 \text{ in.}$

$$\frac{1}{10} = \frac{x}{3}$$

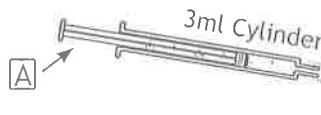

44. Complete the following equation to find the force at piston B ( $\text{Force}_{out}$ ).

Calculate the  $\text{force}_{out}$  by cross multiplying.

$$\text{Ideal Mechanical Advantage} \rightarrow \frac{\text{Distance}_{in}}{\text{Distance}_{out}} = \frac{\text{Force}_{out}}{\text{Force}_{in}} \rightarrow \frac{1 \text{ in}}{20 \text{ lbs}} = \frac{3/10 \text{ in}}{6 \text{ lbs}}$$

45. Mechanical Advantage =  $10/3$ . Calculate by dividing the  $\text{Force}_{out}$  by the  $\text{Force}_{in}$  or the  $\text{Distance}_{in}$  by the  $\text{Distance}_{out}$ .



## FORCE FOR DISTANCE

Set up the 3ml to 10ml hydraulic system, as shown, so it will lift a book. Experiment with it to answer the questions below.

46. If piston **J** moves 1 inch,  
piston **K** moves

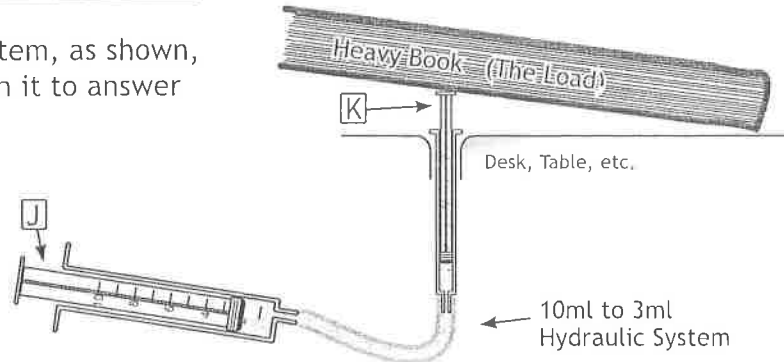

47. Complete the following equation to find the force at piston **K**

Ideal  
Mechanical  
Advantage



$$\frac{\text{Distance}_{in}}{\text{Distance}_{out}} = \frac{\text{Force}_{out}}{\text{Force}_{in}}$$



$$\frac{1 \text{ in}}{\text{10/3 in}} = \frac{\text{9/5 lbs}}{6 \text{ lbs}}$$

Calculate the force<sub>out</sub> by cross multiplying.

48. Mechanical Advantage =

Calculate by dividing the Force<sub>out</sub> by the Force<sub>in</sub> or  
the Distance<sub>in</sub> by the Distance<sub>out</sub>.

Hint: This number should be less than 1 because this system loses force to gain distance.

## HYDRAULIC CYLINDERS = A LEVER

Two connected hydraulic cylinders act like a lever; they change the force, distance and direction movement.

49. Label the Force<sub>in</sub> and Force<sub>out</sub> on the cylinders below to show a mechanical advantage similar to the lever.

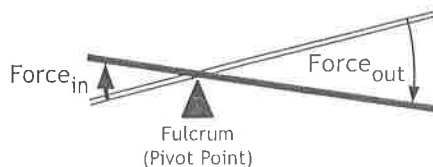

50. Label the Force<sub>in</sub> and Force<sub>out</sub> on the cylinders below to show a mechanical advantage similar to the lever.

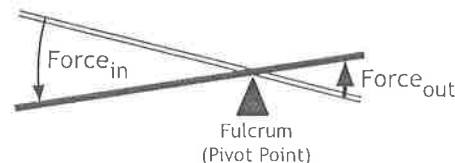



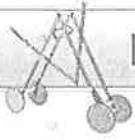

## HOW DOES MECHANICAL ADVANTAGE DEVELOP?

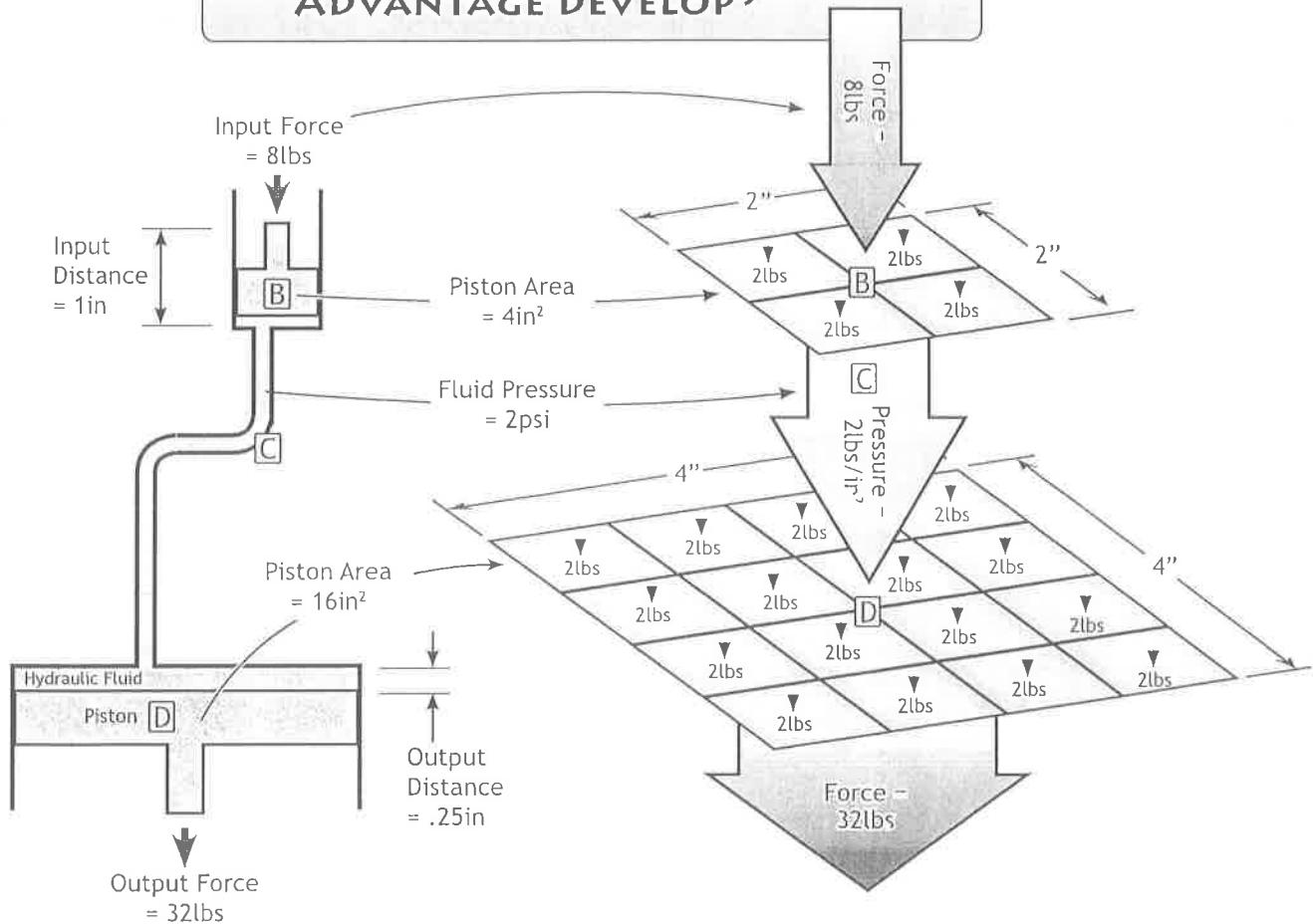

1<sup>st</sup>: 8lbs of force is applied to the piston **B**.

2<sup>nd</sup>: The 8lbs of force is divided over the area of piston **B** and transferred to the fluid (**C**):

$$\begin{array}{l} \text{Force} \rightarrow \\ \text{Piston's Area} \rightarrow \end{array} \frac{2\text{lbs}}{4\text{in}^2} = 2\text{lbs/in}^2 \leftarrow \text{Fluid Pressure}$$

3<sup>rd</sup>: Pressure is transferred through fluid **C** (Pascal's Law) to piston **D**.

4<sup>th</sup>: Fluid **C** presses against every square inch of piston **D**, creating 32lbs of force:

$$\begin{array}{l} \text{Fluid Pressure} \rightarrow \\ \text{Area of Piston } \mathbf{D} \rightarrow \end{array} 2\text{lbs/in}^2 \cdot 16\text{in}^2 = 32\text{lbs} \leftarrow \text{Output Force}$$

← Note: The /in<sup>2</sup> and in<sup>2</sup> cancel each other out.

5<sup>th</sup>: Piston **D** applies a downward force of 32lbs.

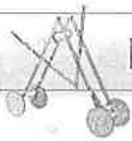

YOU'RE ON YOUR OWN...

A. Find the Force<sub>out</sub>, Distance<sub>out</sub> and mechanical advantage of the hydraulic system below. Show all work.

Total Points: /10

Pressure Developed From Force Applied Over Piston Area: 9.43 psi

$$P = \frac{6 \text{ lbs}}{(.45 \text{ in})^2 \pi}$$

$$MA = \frac{D_{in}}{D_{out}} = \frac{F_{out}}{F_{in}}$$

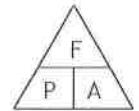

~~P = F/A~~  
 $P = \frac{F}{A}$

9.43 psi

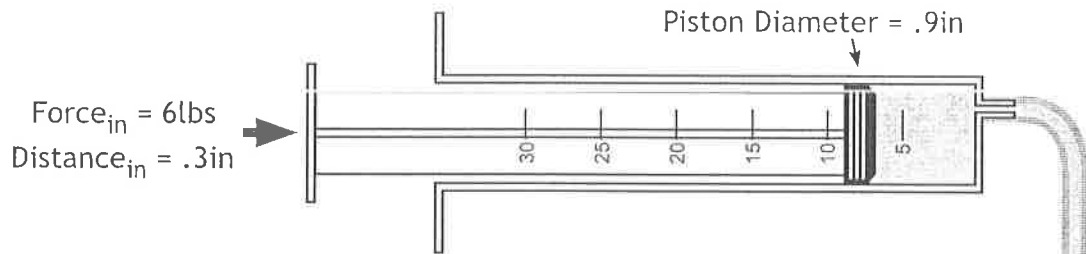

Piston Force Developed From Fluid Pressure Over Piston Area: 9.43 psi

Force<sub>out</sub> = 0.296 lbs  
Distance<sub>out</sub> = 6.08 in

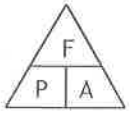
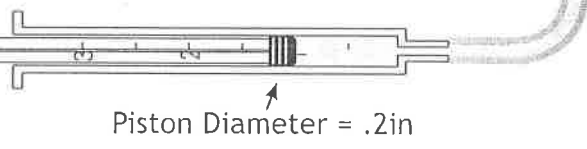

~~9.43 psi = F / (.1 in)^2 pi~~

$$MA = \frac{D_{in}}{D_{out}} = \frac{F_{out}}{F_{in}}$$

$$\frac{F}{A} = \frac{F}{A} = \frac{6 \text{ lbs}}{(.45 \text{ in})^2 \pi} = \frac{F}{(.1 \text{ in})^2 \pi}$$

$$F_{out} = 0.296 \text{ lbs}$$

$$\frac{.3 \text{ in}}{D_{out}} = \frac{0.296 \text{ lbs}}{6 \text{ lbs}}$$

$$MA = \frac{0.296 \text{ lbs}}{6 \text{ lbs}}$$

$$D_{out} = 6.08 \text{ in}$$

Mechanical Advantage: 0.05

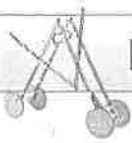

## A FLUID POWERED INVENTION

B. Design and draw an invention that uses hydraulics or pneumatics to perform one of the following tasks: open a jar, crack an egg, toss a ball

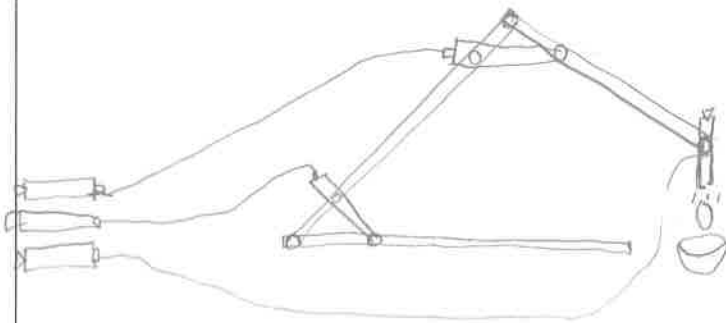

Presentation	Is it well drawn and easy to understand?	/3
Function	Could it really work? Does it use fluid power?	/3
Creativity	Does it solve the task in a new and different way?	/4
Total Points:		/10

**CONGRATULATIONS !!! YOU'VE FINISHED THE FLUID POWER LAB.  
IT'S TIME TO CREATE A FLUID POWERED CONTRAPTION.**

OK

